

STEREO INTEGRATED AMPLIFIER
KA-76
 SERVICE MANUAL

KENWOOD

©1987-3 PRINTED IN JAPAN
 B51-3201-00(T)2347

12
 15
 26
 27
 31
 15
 er

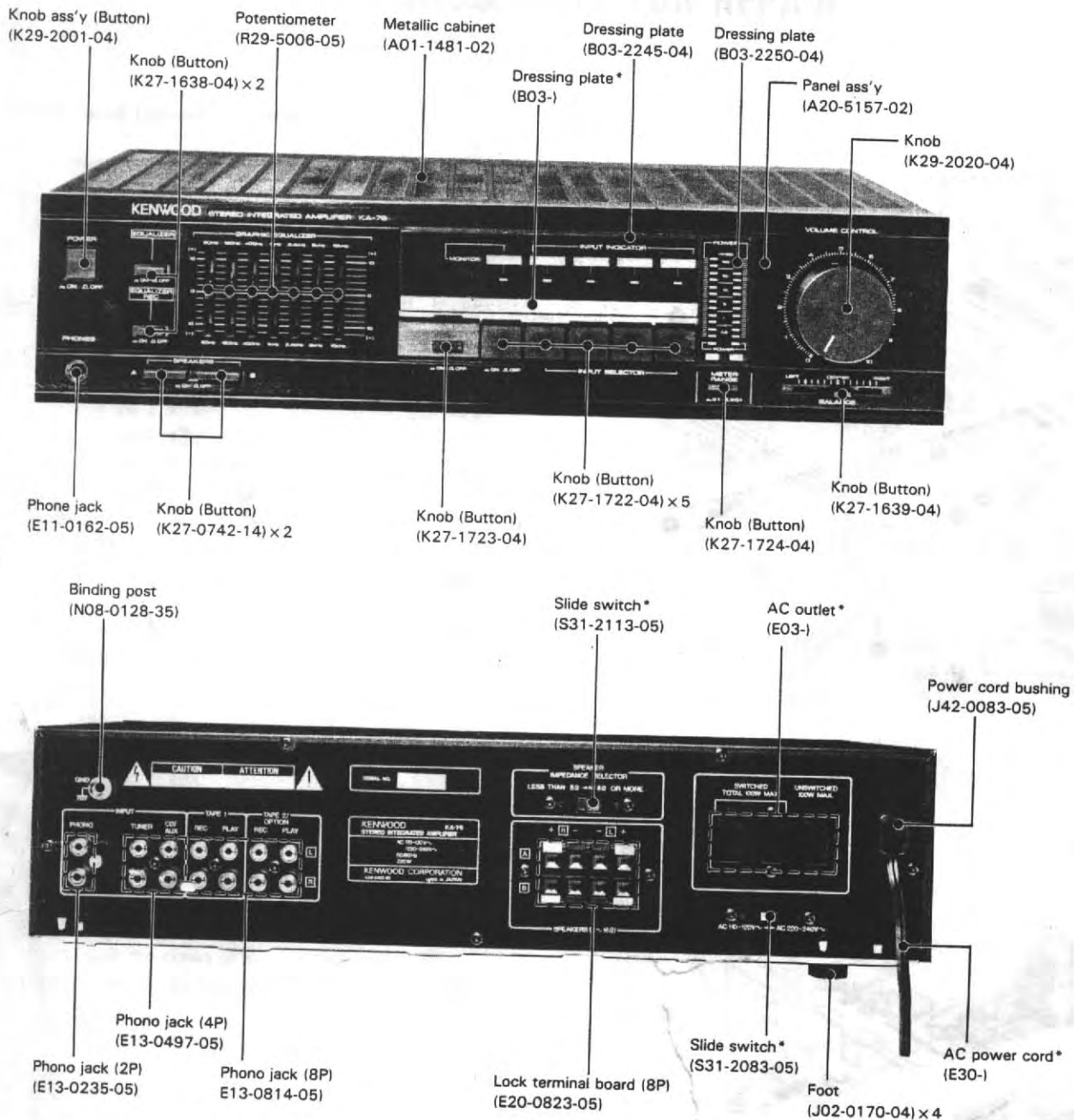

* Refer to parts list on page 27.
 Photo is KA-76 (U.S.A. and Canada models).

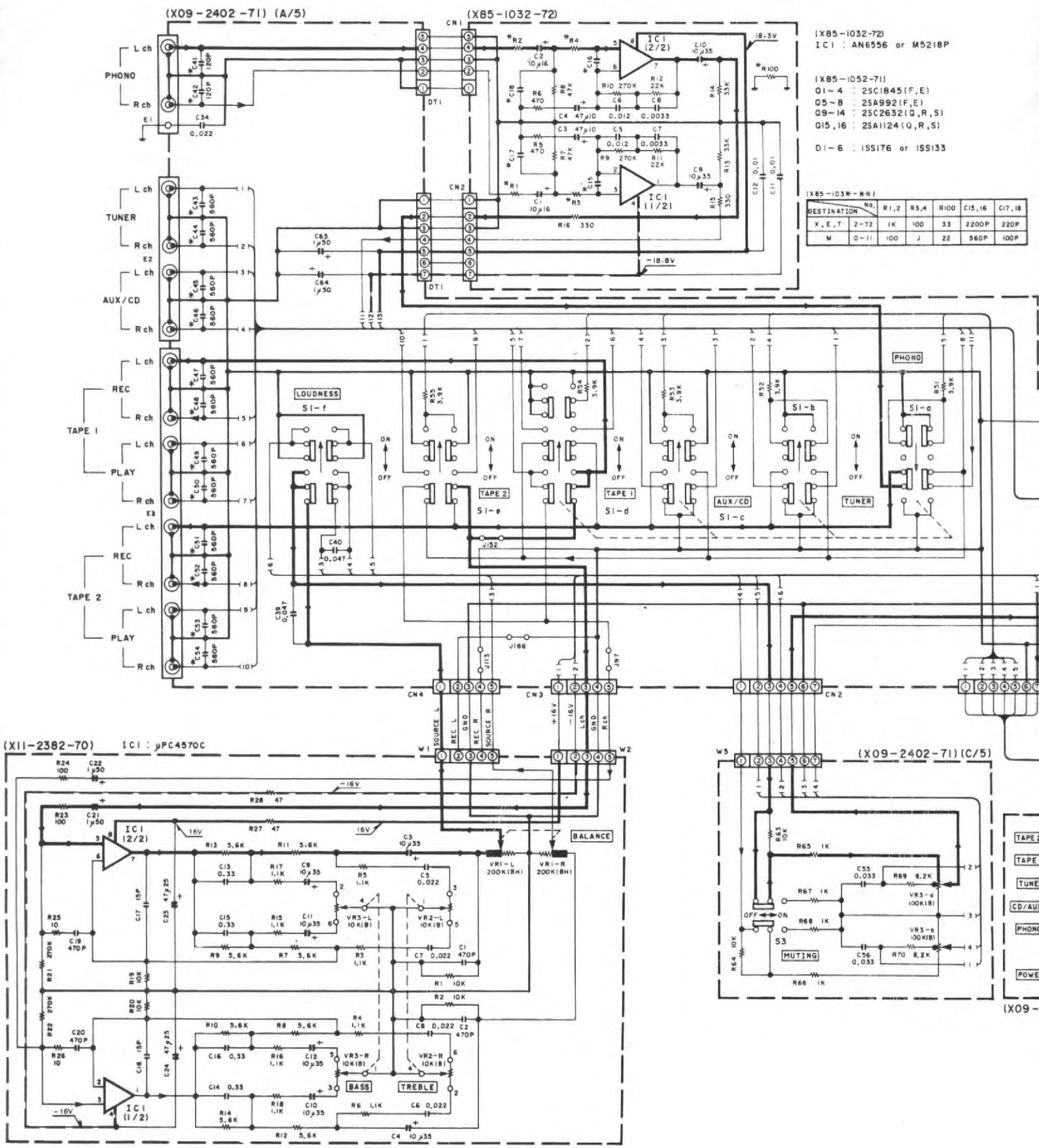

[X85-1032-72]
IC1 : AN6556 or M5218P

[X85-1052-71]
Q1-4 : 2SC1845 (F,E)
Q5-8 : 2SA992 (F,E)
Q9-14 : 2SC2632 (Q,R,S)
Q15,16 : 2SA1124 (Q,R,S)

D1-6 : 1SS176 or 1SS133

[X85-103*-*)

DESTINATION	No.	R1,2	R3,4	R100	C15,16	C17,18
X, E, T	2-72	1K	100	33	2200P	220P
M	0-11	100	J	22	560P	100P

- TAPE 2
- TAPE 1
- TUNER
- CD/AUX
- PHONO
- POWER

2SA1124
2SA733 (A)
2SA992
2SC1845
2SC2632

2SC3419

2SB1162
2SB1163
2SD1717
2SD1718

2SA1535
2SC3944

AN6556
M5218P
μPC4570C

UPC1237HA

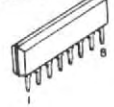
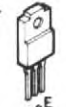
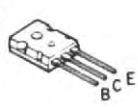
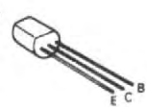

(X85-1052-71)

or M521BP

R45(F, E)
R2(F, E)
R32(I, R, S)
R24(I, R, S)

of ISS133

R1,2	R3,4	R100	C15,16	C17,18
1K	100	33	2200P	220P
100	1	22	560P	100P

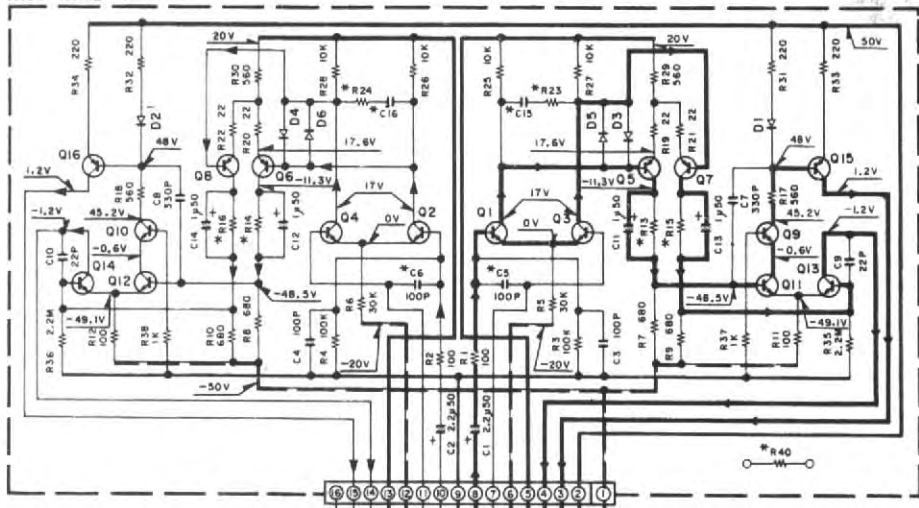

DESTINATION	R13-16	R23	R24	R40	C5,6	
X, E, T	2-71	8.2K	180	33	YES	
M	0-11	10K	130	130	10	NO

(X09-2402-71) (B/5)

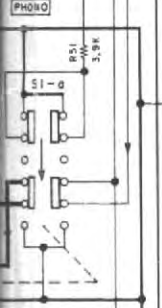
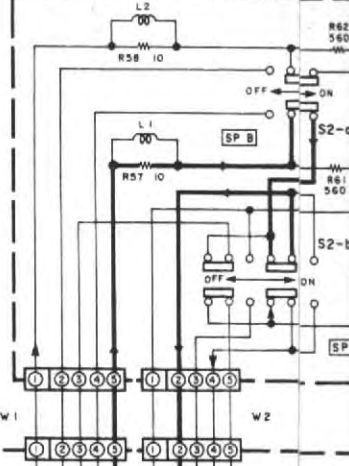

(X09-2402-71) (C/5)

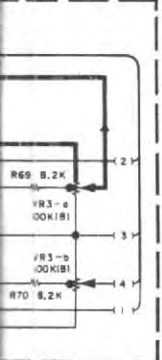

(X09-2402-71) (E/5)

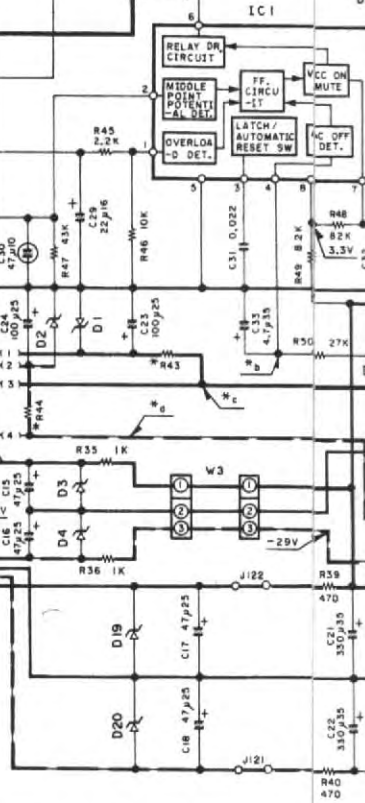
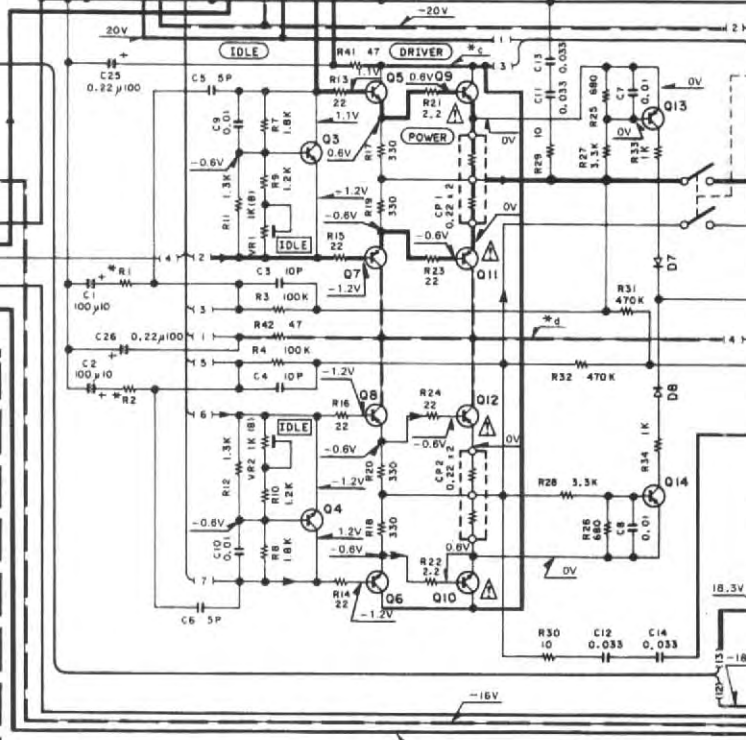
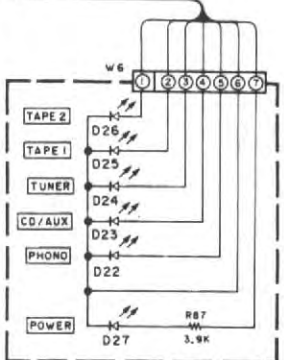

DC voltages are as measured with a high impedance voltmeter with no signal input. Values may vary slightly due to variations between individual instruments or/and units.

Les tensions c.c. doivent être mesurées avec un voltmètre à haute impédance sans signal d'entrée. Les valeurs peuvent différer légèrement du fait des variations inhérentes aux appareils et aux instruments de mesure individuels.

Die angegebenen Werte sind mit einem hochohmigen Voltmeter ohne Signal gemessen. Die Werte können aufgrund von individuellen Instrumenten...

R23	R24	R40	C5, 6	C15, 16
180	180	53	YES	220P
130	130	10	NO	1500P

(X09-2402-71)
IC1 : μ PC1237HA

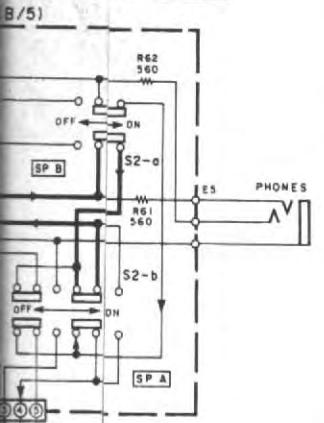

- Q3, 4 : 2SC3419(Y)
- Q5, 6 : 2SC3944
- Q7, 8 : 2SA1535
- Q9, 10 : 2SD1718 or 2SD1717
- Q11, 12 : 2SB1163 or 2SB1162
- Q13, 14 : 2SA733(A)(Q, P)

- D1, 2 : RD20ES(B) or HZS20S(B)
- D3, 4, 19, 20 : RD16ES(B) or HZS16S(B)
- D7, 8, 28, 29 : ISS133 or ISS176
- D9-12 : DSM1A1
- D21 : RBV-60ZLFA
- D22-27 : B30-0431-05

(X09-240M-**) No. a b c d

X, E, T	2-71	45V (133V)	1.8V	60V (44V)	-60V (-44V)
M	0-21	49V (35V)	2.7V	67V (47V)	-67V (-47V)

(X09-240M-**) DESTINATION No. R1, 2 R43 R44 C27, 28 C41-54 C66-70

X, E, T	2-71	560	1.2K	3.3K	7500 μ 80	YES	YES
M	0-21	510	2.7K	4.7K	8200 μ 71	NO	NO

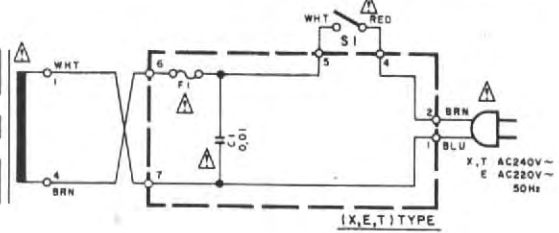
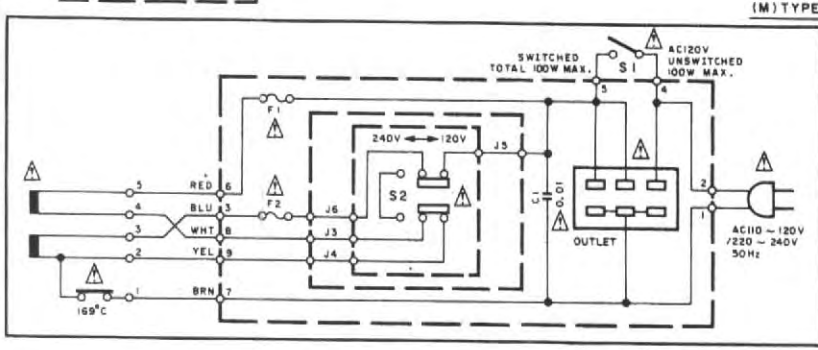
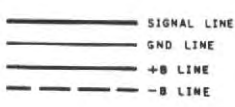
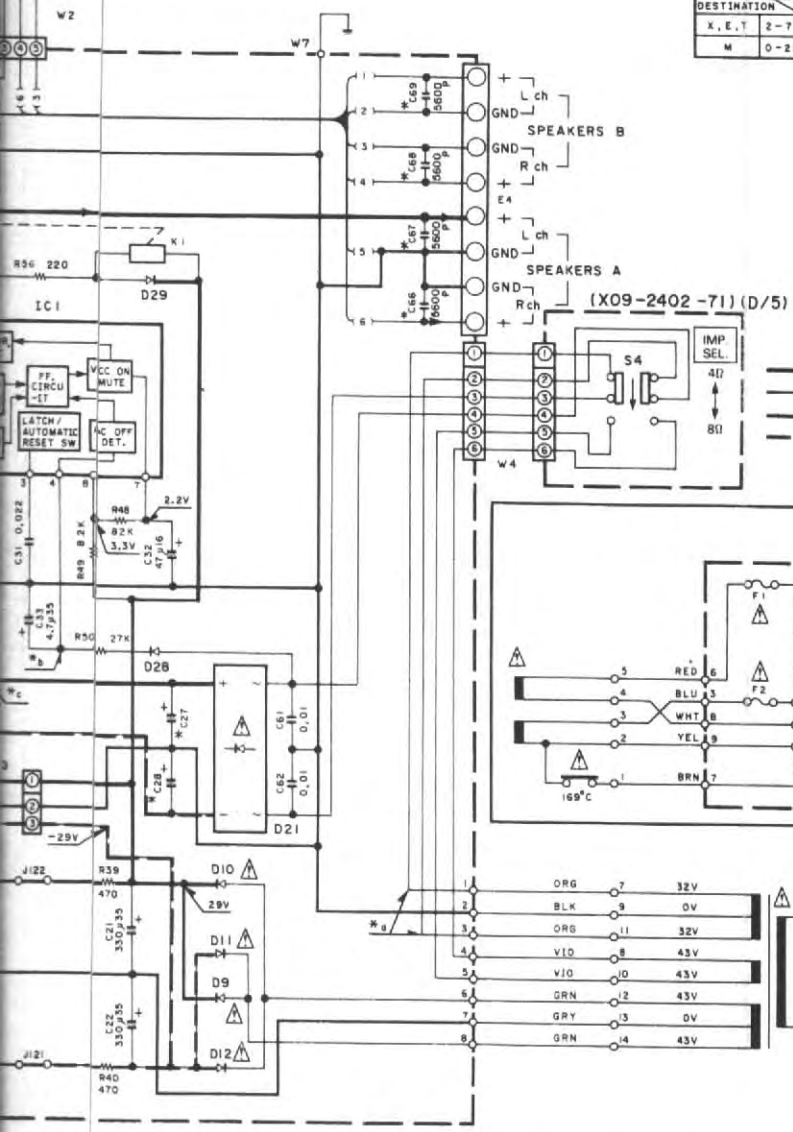

KA-76(E)

CAUTION: For continued safety, replace safety critical components only with manufacturer's recommended parts (refer to parts list). Indicates safety critical components. To reduce the risk of electric shock, leakage-current or resistance measurements shall be carried out (exposed parts are acceptably insulated from the supply circuit) before the appliance is returned to the customer.

Built-in tone controls

KA-76

KENWOOD

Die angegebenen Gleichspannungswerte wurden mit einem hochohmigen Spannungsmesser ohne Eingangssignal gemessen. Dabei schwanden die Meßwerte aufgrund von Unterschieden zwischen einzelnen Instrumenten oder Geräten u.U. geringfügig.

CIRCUIT DESCRIPTION/ADJUSTMENT/REGLAGES/ABGLEICH

7 band graphic equalizer IC (IC1, 2) : M5229P (X11-2250-10) (K, P, U & UE types)

• Block diagram

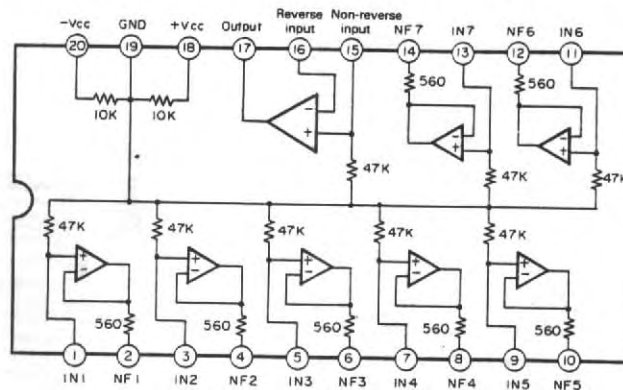

ADJUSTMENT

No.	ITEM	INPUT SETTINGS	OUTPUT SETTINGS	AMPLIFIER SETTINGS	ALIGNMENT POINTS	ALIGN FOR	FIG.
1	IDLE CURRENT	-	Connect a DC voltmeter across CP1 (L) CP2 (R)	VOLUME: 0	VR1 (L) VR2 (R)	3mV	(a)

REGLAGES

N°	ITEM	REGLAGE DE L'ENTREE	REGLAGE DE LA SORTIE	REGLAGE DE L'AMPLIFICATEUR	POINS L'ALIGNEMENT	ALIGNER POUR	FIG.
1	COURANT DE POLARISATION	-	Connecter un voltmètre de CC sur CP1 (G) CP2 (D)	VOLUME: 0	VR1 (G) VR2 (D)	3mV	(a)

ABGLEICH

NR.	GEGENSTAND	EINGANGS-EINSTELLUNG	AUSGANGS-EINSTELLUNG	VERSTÄRKER EINSTELLUNG	ABGLEICH-PUNKTE	ABGLEICHEN FÜR	ABB.
1	LEERLAUFSTROM	-	Einen Gleichspannungsmesser ber CP1 (L) CP2 (R) anschließen.	VOLUME: 0	VR1 (L) VR2 (R)	3mV	(a)

(a)

